



ACE13006M

N-Channel 60-V (D-S) MOSFET

Features

- Low $r_{DS(on)}$ trench technology
- Low thermal impedance
- Fast switching speed

Product Summary		
V_{DS} (V)	$r_{DS(on)}$ (m Ω)	I_D (A)
60	65 @ $V_{GS} = 10V$	23
	75 @ $V_{GS} = 4.5V$	21

Applications

- Automotive Systems
- DC/DC Conversion Circuits
- Battery Powered Power Tools

Absolute Maximum Ratings

Parameter	Symbol	Limit	Units
Drain-Source Voltage	V_{DS}	60	V
Gate-Source Voltage	V_{GS}	± 20	V
Continuous Drain Current ^a	I_D	23	A
$T_A = 25^\circ C$			
Pulse Drain Current ^b	I_{DM}	90	A
Continuous Drain Current (Diode Continuous) ^a	I_S	30	A
Power Dissipation ^a	P_D	50	W
$T_A = 25^\circ C$			
Operating Junction and Storage Temperature Range	T_J, T_{STG}	-55 to 150	$^\circ C$

Parameter	Symbol	Maximum	Units
Maximum Junction-to-Ambient ^a	$R_{\theta JA}$	40	$^\circ C/W$
Maximum Junction-to-Case	$R_{\theta JC}$	3	$^\circ C/W$

Notes

a. Surface Mounted on 1" x 1" FR4 Board.

b. Pulse width limited by maximum junction temperature

Packaging Type

TO-252

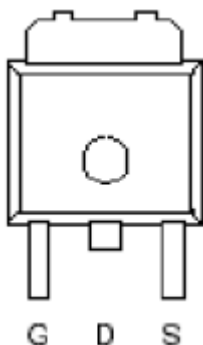



ACE13006M

N-Channel 60-V (D-S) MOSFET

Ordering information

ACE13006M XX + H

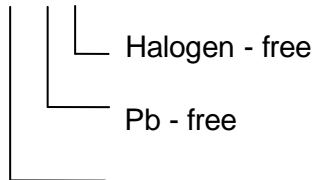

YM: TO-252

Electrical Characteristics

Parameter	Symbol	Conditions	Min.	Typ.	Max.	Unit
Static						
Gate Source Threshold Voltage	$V_{GS(th)}$	$V_{DS}=V_{GS}, I_D=250\mu A$	1			V
Gate Body Leakage	I_{GSS}	$V_{DS}=0V, V_{GS}=\pm 20V$			± 100	nA
Zero Gate Voltage Drain Current	I_{DSS}	$V_{DS}=48V, V_{GS}=0V$			1	uA
		$V_{DS}=48V, V_{GS}=0V, T_J=55^\circ C$			25	
On-State Drain-Current ^a	$I_{D(on)}$	$V_{DS}=5V, V_{GS}=10V$	35			A
Drain-Source On-Resistance ^a	$r_{DS(ON)}$	$V_{GS}=10V, I_D=18.1A$			65	mΩ
		$V_{GS}=4.5V, I_D=14.5A$			78	
Forward Transconductance ^a	g_{fs}	$V_{DS}=15V, I_D=18A$		15		S
Diode Forward Voltage ^a	V_{SD}	$I_S=15A, V_{GS}=0V$		0.95		V
Dynamic ^b						
Total Gate Charge	Q_g	$V_{DS}=30V, V_{GS}=4.5V, I_D=18.1A$		3.6		nC
Gate-Source Charge	Q_{gs}			1.3		
Gate-Drain Charge	Q_{gd}			1.7		
Turn-On Delay Time	$t_{d(on)}$	$V_{DS}=30V, R_L=1.7\Omega, I_D=18.1A, V_{GEN}=10V, R_{GEN}=6\Omega,$		3		ns
Rise Time	t_f			4		
Turn-Off Delay Time	$t_{d(off)}$			17		
Fall Time	t_f			5		
Input Capacitance	C_{iss}	$V_{DS}=15V, V_{GS}=0V, f=1MHz$		405		pF
Output Capacitance	C_{oss}			61		
Reverse Transfer Capacitance	C_{rss}			33		

Note:

- a. Pulse test: PW ≤ 300us duty cycle ≤ 2%.
- b. Guaranteed by design, not subject to production testing.



ACE13006M

N-Channel 60-V (D-S) MOSFET

Typical Electrical Characteristics

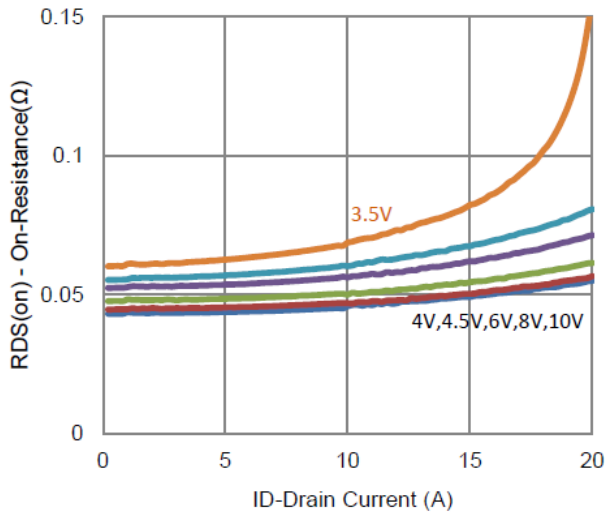

1. On-Resistance vs. Drain Current

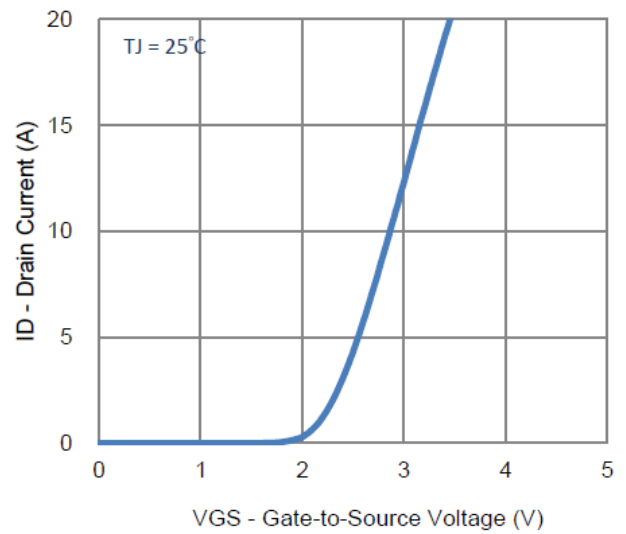

2. Transfer Characteristics

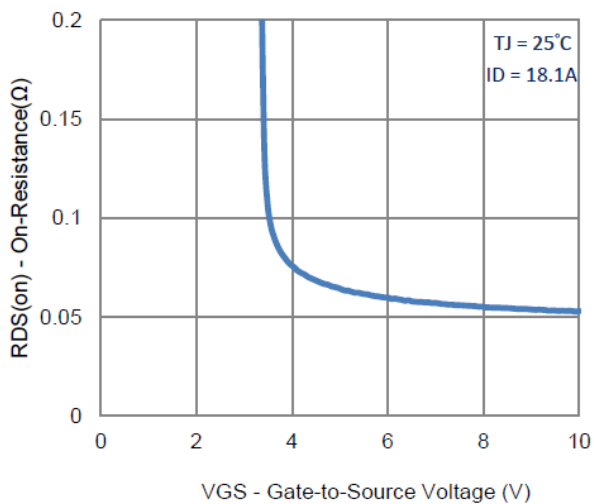

3. On-Resistance vs. Gate-to-Source Voltage

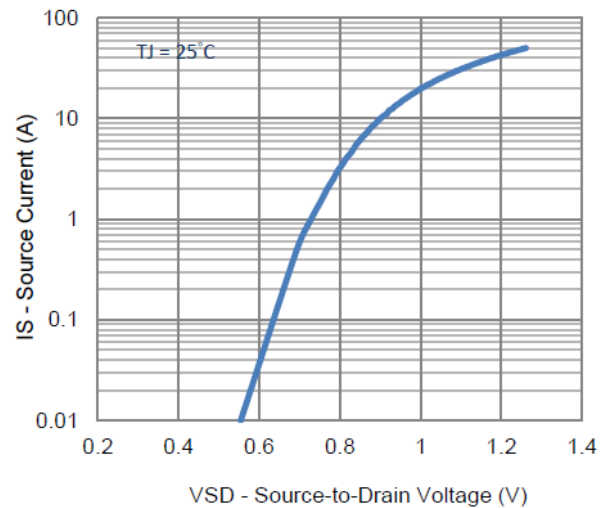

4. Drain-to-Source Forward Voltage

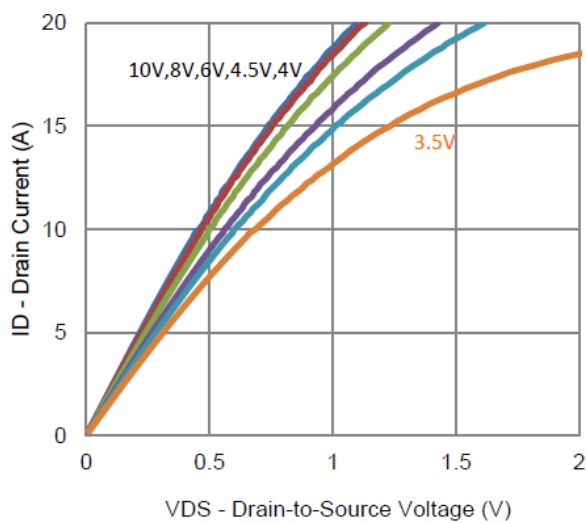

5. Output Characteristics

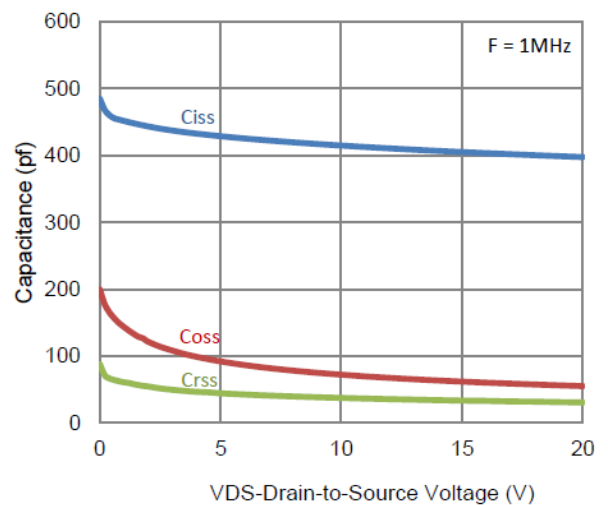

6. Capacitance



ACE13006M

N-Channel 60-V (D-S) MOSFET

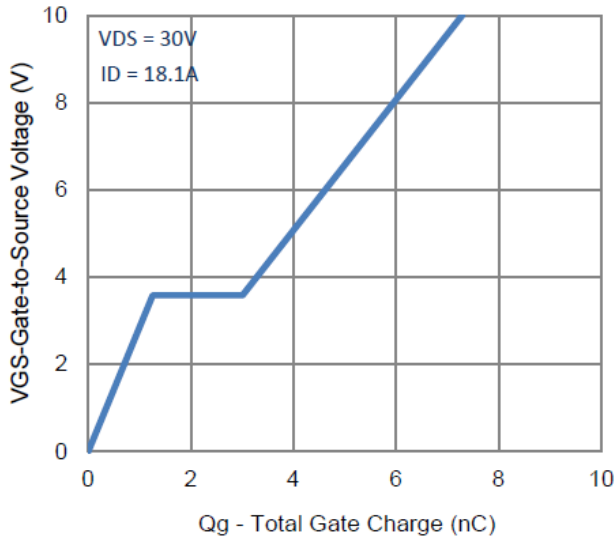

7. Gate Charge

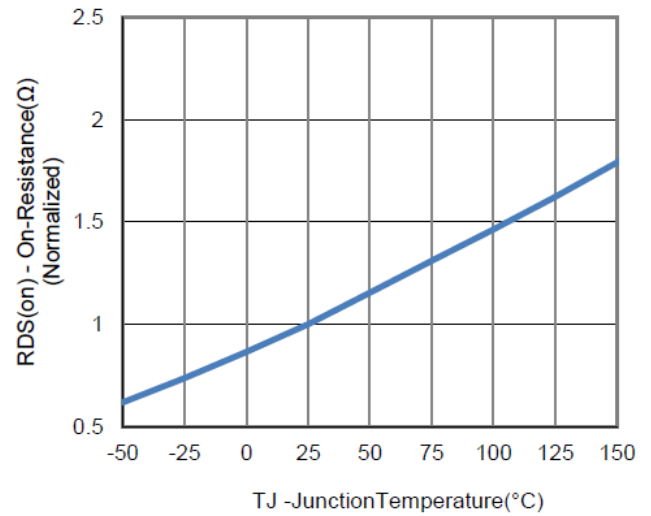

8. Normalized On-Resistance Vs Junction Temperature

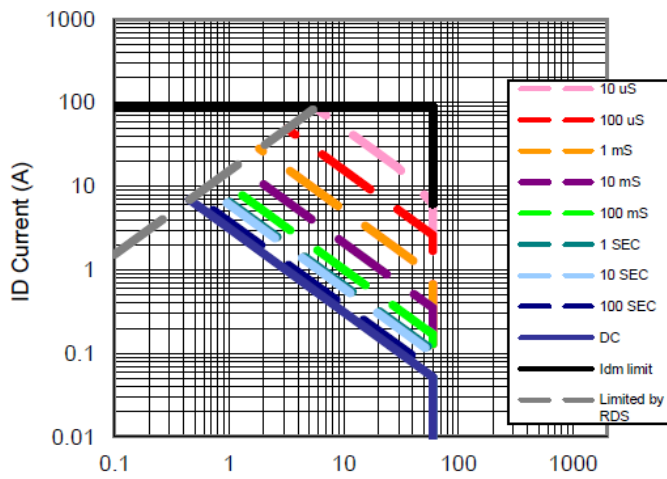

9. Safe Operating Area

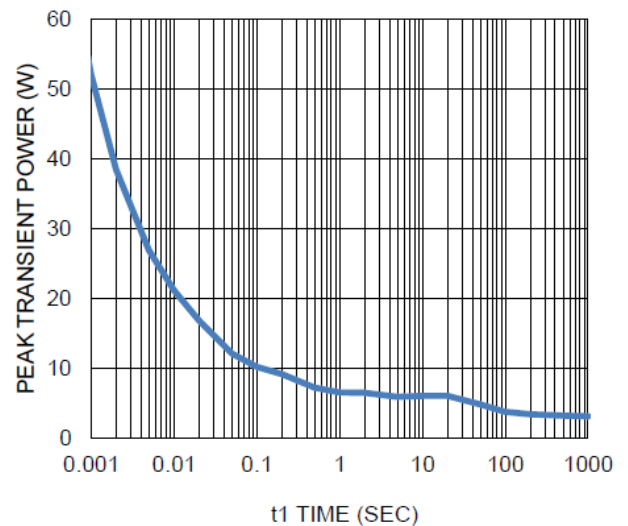

10. Single Pulse Maximum Power Dissipation

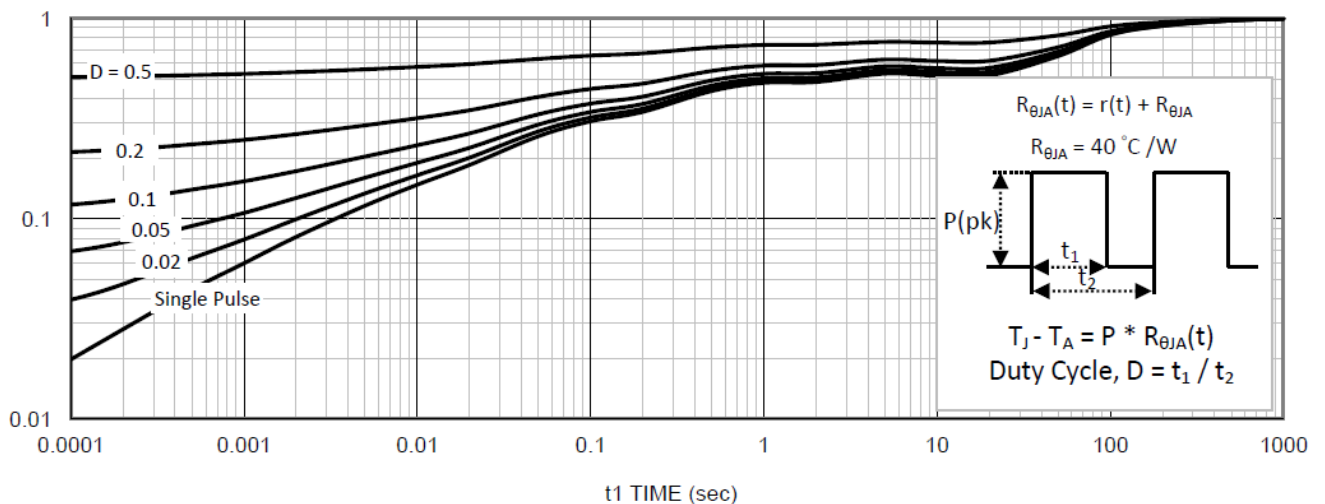

11. Normalized Thermal Transient Junction to Ambient



ACE13006M

N-Channel 60-V (D-S) MOSFET

Packing Information

TO-252

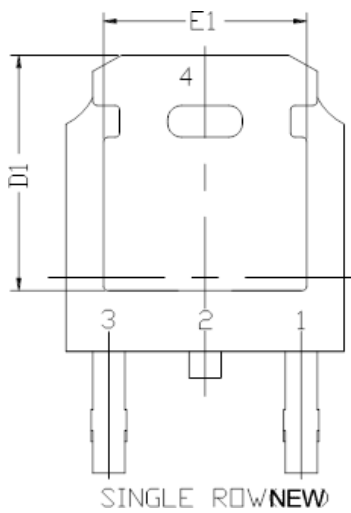
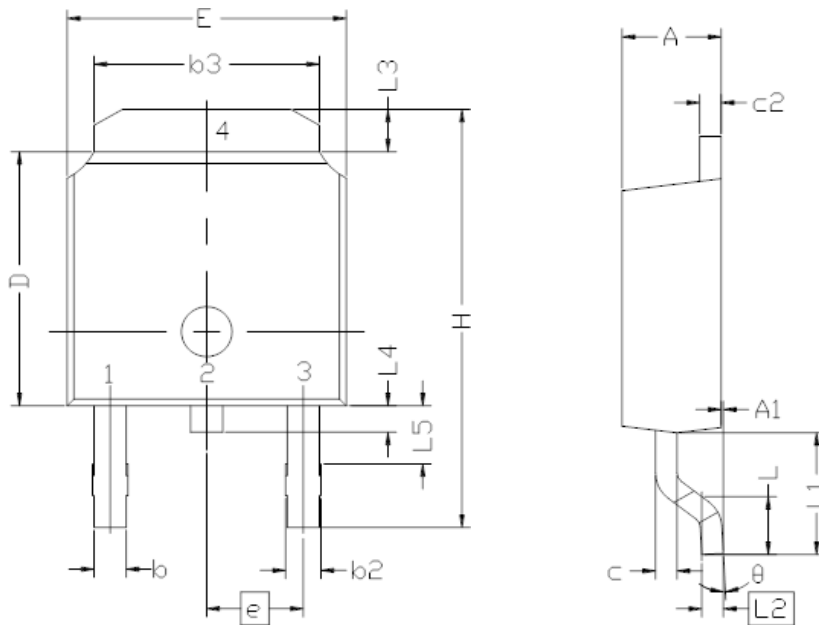

Symbols	Dimensional Reqmts		
	MIN	NOM	MAX
E	6.40	6.60	6.731
L	1.40	1.52	1.77
L1	2.743 REF		
L2	0.508 BSC		
L3	0.89		1.27
L4	0.64		101
L5			
D	6.00	6.10	6.223
H	9.40	10.00	10.40
b	0.64	0.76	0.88
b2	0.77	0.84	1.14
b3	5.21	5.34	5.46
e	2.286 BSC		
A	2.20	2.30	2.38
A1	0		0.127
c	0.45	0.50	0.60
c2	0.45	0.50	0.58
D1	5.30		
E1	4.40		
θ1	0°		10°



ACE13006M

N-Channel 60-V (D-S) MOSFET

Notes

ACE does not assume any responsibility for use as critical components in life support devices or systems without the express written approval of the president and general counsel of ACE Electronics Co., LTD. As sued herein:

1. Life support devices or systems are devices or systems which, (a) are intended for surgical implant into the body, or (b) support or sustain life, and whose failure to perform when properly used in accordance with instructions for use provided in the labeling, can be reasonably expected to result in a significant injury to the user.
2. A critical component is any component of a life support device or system whose failure to perform can be reasonably expected to cause the failure of the life support device or system, or to affect its safety or effectiveness.

ACE Technology Co., LTD.
<http://www.ace-ele.com/>