



ACE1534B

N-Channel Power MOSFET

Description

ACE1534B uses advanced trench technology to provide excellent $R_{DS(ON)}$ and low gate charge. This device is suitable for use as a load switch or in PWM applications. The source leads are separated to allow a Kelvin connection to the source, which may be used to bypass the source inductance.

Features

- $V_{DS} = 30V$, $I_D = 130A$
- $R_{DS(ON)} @ V_{GS} = 10V$, TYP= $1.2m\Omega$
- $R_{DS(ON)} @ V_{GS} = 4.5V$, TYP= $1.8m\Omega$

Absolute Maximum Ratings @ $T_A = 25^\circ C$ unless otherwise noted

Parameter	Symbol	Max	Unit
Drain-Source Voltage	V_{DSS}	30	V
Gate-Source Voltage	V_{GSS}	± 20	V
Drain Current (Continuous)*AC	I_D	$T_A = 25^\circ C$	130
		$T_A = 100^\circ C$	82
Drain Current (Pulsed)*B	I_{DM}	520	A
Power Dissipation	$T_A = 25^\circ C$	P_D	166
Operating temperature / Storage temperature	T_J / T_{STG}	-55~150	$^\circ C$

A: The value of $R_{\theta JA}$ is measured with the device mounted on $1in^2$ FR-4 board with 2oz. Copper, in a still air environment with $T_A = 25^\circ C$. The value in any given application depends on the user's specific board design.

B: Repetitive rating, pulse width limited by junction temperature.

C: The current rating is based on the $t \leq 10s$ junction to ambient thermal resistance rating.

Packaging Type

DFN5*6-EP

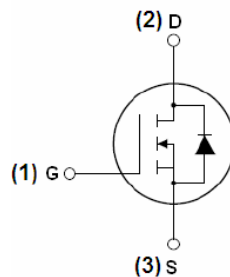
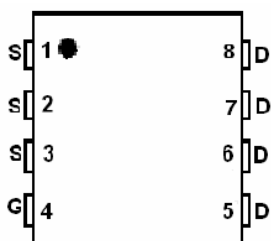



ACE1534B

N-Channel Power MOSFET

Ordering information

ACE1534B XX + H

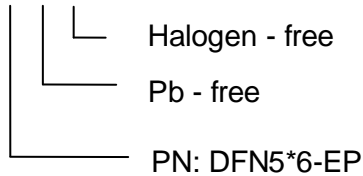

Electrical Characteristics $T_A=25^\circ\text{C}$, unless otherwise specified.

Parameter	Symbol	Test Conditions	Min	Typ	Max	Unit
Static						
Drain-source breakdown voltage	$V_{(BR)DSS}$	$V_{GS}=0V, I_D=250\mu A$	30			V
Zero gate voltage drain current	I_{DSS}	$V_{DS}=27V, V_{GS}=0V$			1	μA
Gate threshold voltage	$V_{GS(th)}$	$V_{GS}=V_{DS}, I_{DS}=250\mu A$	1.0	1.6	2.5	V
Gate leakage current	I_{GSS}	$V_{GS}=\pm 20V, V_{DS}=0V$			± 100	μA
Drain-source on-state resistance	$R_{DS(on)}$	$V_{GS}=10V, I_D=30A$		1.2	1.6	m Ω
		$V_{GS}=4.5V, I_D=15A$		1.8	2.4	
Forward Trans conductance	g_{FS}	$V_{DS}=10V, I_D=15A$		30		S
Diode forward voltage	V_{SD}	$I_{SD}=1A, V_{GS}=0V$		0.65	1	V
Maximum body-diode continuous current	I_S				130	A
Switching						
Total Gate Charge	Q_g	$V_{GS}=10V, V_{DS}=15V, I_D=10A$		65.2	120	nC
Gate-Source Charge	Q_{gs}			16	30	
Gate-Drain Charge	Q_{gd}			21	40	
Turn-on Delay Time	$t_{d(on)}$	$V_{DD}=15V, I_D=1A, V_{GS}=10V, R_G=3.3\Omega$		28	56	ns
Turn-on Rise Time	t_r			45	90	
Turn-off Delay Time	$t_{d(off)}$			105	200	
Turn-off Fall Time	t_f			40	80	
Dynamic						
Input Capacitance	C_{iss}	$V_{GS}=0V, V_{DS}=25V, f=1.0MHz$		7720		pF
Output Capacitance	C_{oss}			945		
Reverse Transfer Capacitance	C_{rss}			435		



ACE1534B

N-Channel Power MOSFET

Typical Performance Characteristics

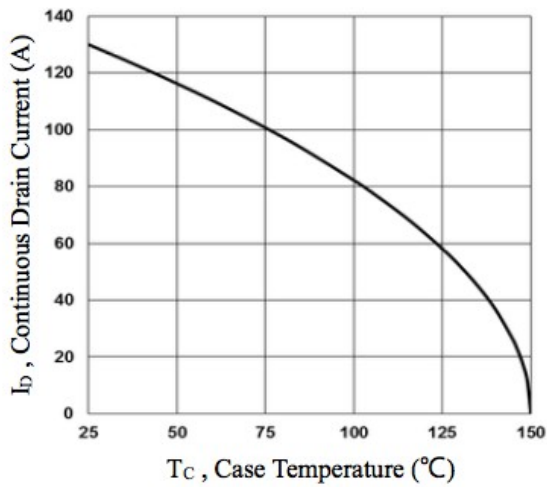

Fig.1 Continuous Drain Current vs. T_C

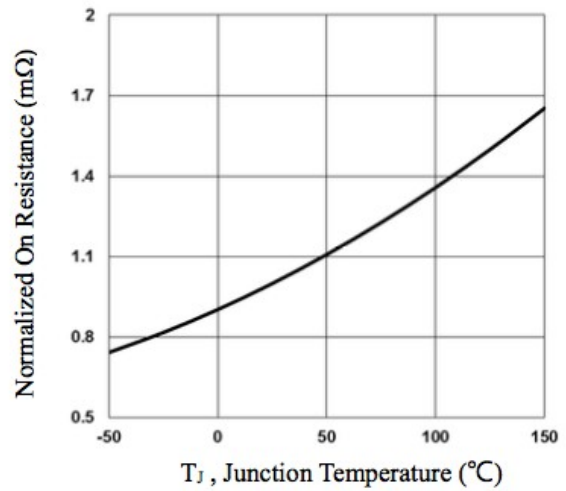

Fig.2 Normalized $R_{DS(on)}$ vs. T_J

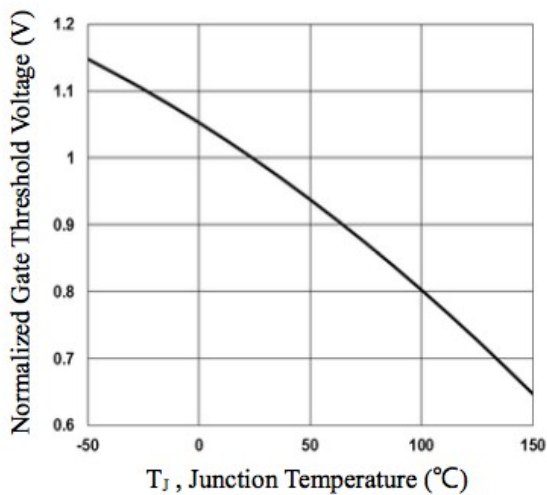

Fig.3 Normalized V_{th} vs. T_J

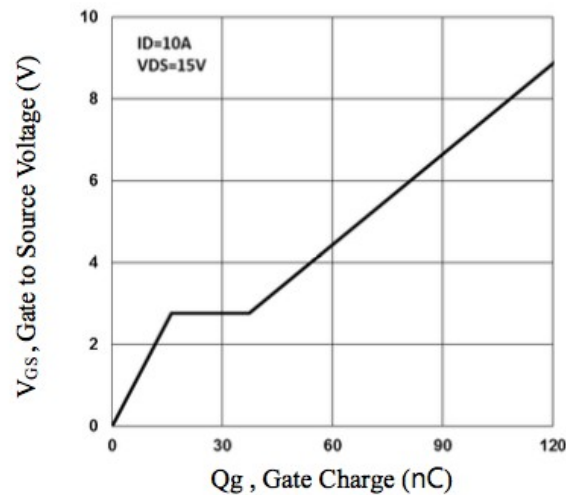

Fig.4 Gate Charge Waveform

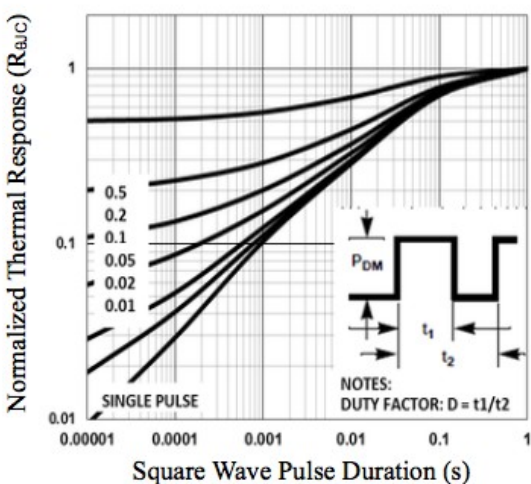

Fig.5 Normalized Transient Impedance

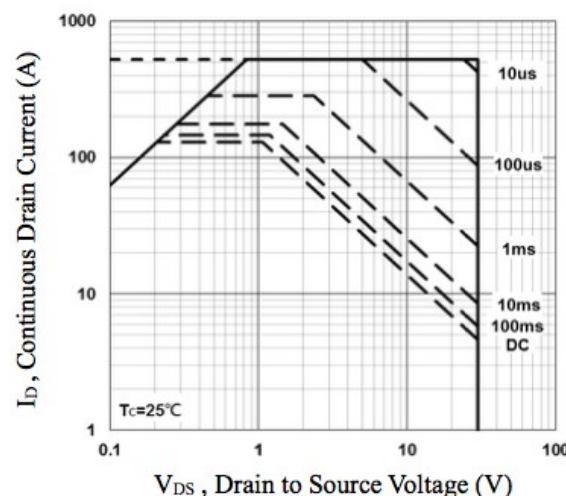

Fig.6 Maximum Safe Operation Area



ACE1534B

N-Channel Power MOSFET

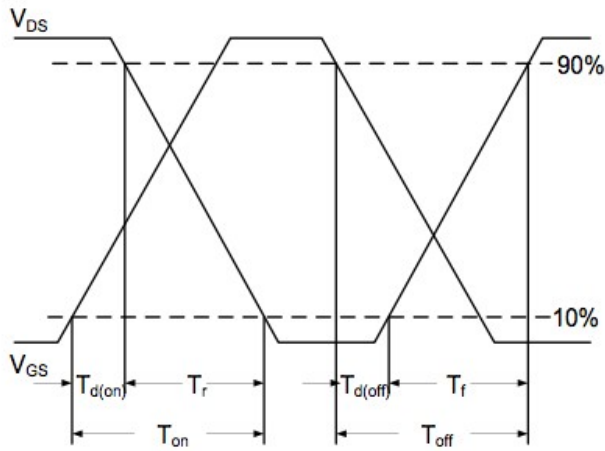

Fig.7 Switching Time Waveform

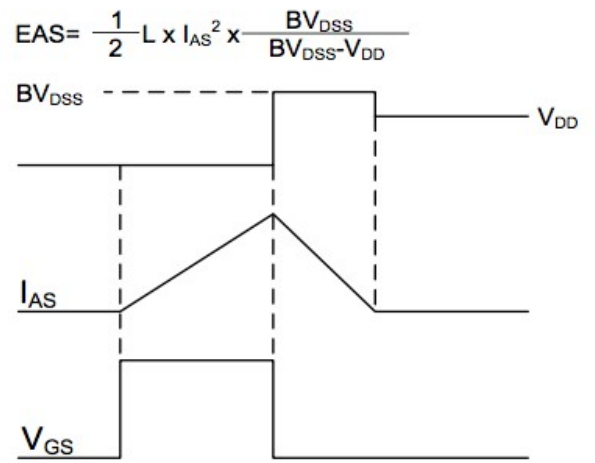

Fig.8 EAS Waveform



ACE1534B

N-Channel Power MOSFET

Packing Information

DFN5*6-EP

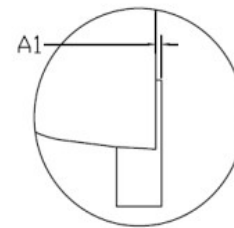
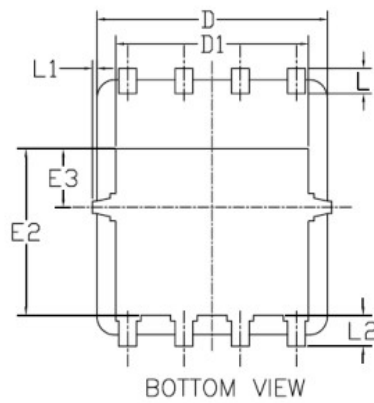
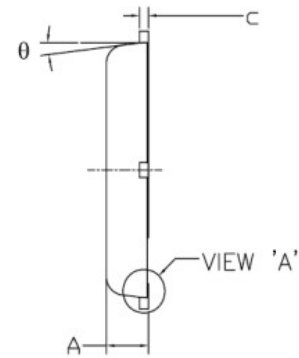
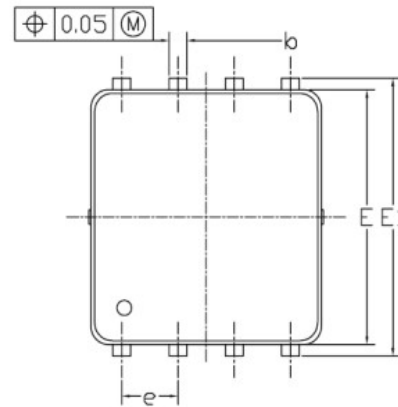

VIEW 'A'
(SCALE 5:1)

RECOMMENDED LAND PATTERN

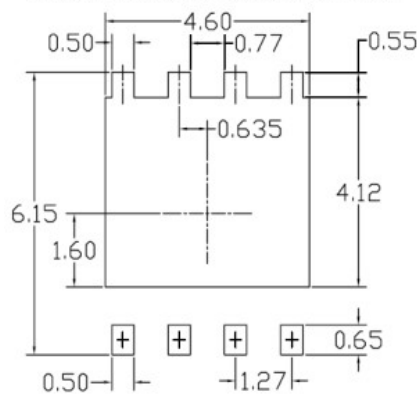

SYMBOLS	DIMENSIONS IN MILLIMETERS			DIMENSIONS IN INCHES		
	MIN	NOM	MAX	MIN	NOM	MAX
A	0.85	0.95	1.00	0.033	0.037	0.039
A1	0.00	—	0.05	0.000	—	0.002
b	0.30	0.40	0.50	0.012	0.016	0.020
c	0.15	0.20	0.25	0.006	0.008	0.010
D	5.20 BSC			0.205 BSC		
D1	4.35 BSC			0.171 BSC		
E	5.55 BSC			0.219 BSC		
E1	6.05 BSC			0.238 BSC		
E2	3.625 BSC			0.143 BSC		
E3	1.275 BSC			0.050 BSC		
e	1.27 BSC			0.050 BSC		
L	0.45	0.55	0.65	0.018	0.022	0.026
L1	0	—	0.15	0	—	0.006
L2	0.68 REF			0.027 REF		
θ	0°	—	10°	0°	—	10°

UNIT: mm

NOTE

1. PACKAGE BODY SIZES EXCLUDE MOLD FLASH AND GATE BURRS.
MOLD FLASH AT THE NON-LEAD SIDES SHOULD BE LESS THAN 6 MILS EACH.
2. CONTROLLING DIMENSION IS MILLIMETER.
CONVERTED INCH DIMENSIONS ARE NOT NECESSARILY EXACT.



ACE1534B

N-Channel Power MOSFET

Notes

ACE does not assume any responsibility for use as critical components in life support devices or systems without the express written approval of the president and general counsel of ACE Electronics Co., LTD. As used herein:

1. Life support devices or systems are devices or systems which, (a) are intended for surgical implant into the body, or (b) support or sustain life, and whose failure to perform when properly used in accordance with instructions for use provided in the labeling, can be reasonably expected to result in a significant injury to the user.
2. A critical component is any component of a life support device or system whose failure to perform can be reasonably expected to cause the failure of the life support device or system, or to affect its safety or effectiveness.