



# ACE2391M

## N-Channel 150-V MOSFET

### Description

ACE2391M uses advanced trench technology to provide excellent  $R_{DS(ON)}$ . This device particularly suits for low voltage application such as power management of desktop computer or notebook computer power management, DC/DC converter.

### Features

- Low  $r_{DS(on)}$  trench technology
- Low thermal impedance
- Fast switching speed

### Applications:

- PoE Power Sourcing Equipment
- PoE Powered Devices
- Telecom DC/DC converters
- White LED boost converters

### Absolute Maximum Ratings

Parameter	Symbol	Limit	Unit	
Drain-Source Voltage	$V_{DS}$	150	V	
Gate-Source Voltage	$V_{GS}$	$\pm 20$		
Continuous Drain Current <sup>a</sup>	$I_D$	$T_A=25^\circ\text{C}$	1.1	A
		$T_A=70^\circ\text{C}$	0.9	
Pulsed Drain Current <sup>b</sup>	$I_{DM}$	5		
Continuous Source Current (Diode Conduction) <sup>a</sup>	$I_S$	1.6	A	
Power Dissipation <sup>a</sup>	$P_D$	$T_A=25^\circ\text{C}$	1.3	W
		$T_A=70^\circ\text{C}$	0.8	
Operating Junction and Storage Temperature Range	$T_J, T_{stg}$	-55 to 150	$^\circ\text{C}$	

### THERMAL RESISTANCE RATINGS

Parameter	Symbol	Maximum	Unit	
Maximum Junction-to-Ambient <sup>a</sup>	$R_{\theta JA}$	$t \leq 10\text{sec}$	100	$^\circ\text{C/W}$
		Steady State	166	

#### Notes

a. Surface Mounted on 1" x 1" FR4 Board.

b. Pulse width limited by maximum junction temperature



# ACE2391M

## N-Channel 150-V MOSFET

### Packaging Type

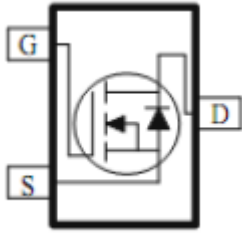

### Ordering information

ACE2391M **BM** + H

- └─ Halogen - free
- └─ Pb - free
- └─ BM : SOT-23-3

### Electrical Characteristics

Parameter	Symbol	Conditions	Min.	Typ.	Max.	Unit
Static						
Gate-Source Threshold Voltage	$V_{GS(th)}$	$V_{DS} = V_{GS}, I_D = 250 \mu A$	1			V
Gate-Body Leakage	$I_{GSS}$	$V_{DS} = 0 V, V_{GS} = \pm 20 V$			$\pm 100$	nA
Zero Gate Voltage Drain Current	$I_{DSS}$	$V_{DS} = 120 V, V_{GS} = 0 V$			1	uA
		$V_{DS} = 120 V, V_{GS} = 0 V, T_J = 55^\circ C$			25	
On-State Drain Current	$I_{D(on)}$	$V_{DS} = 5 V, V_{GS} = 10 V$	5			A
Drain-Source On-Resistance	$r_{DS(on)}$	$V_{GS} = 10 V, I_D = 1.1 A$			0.7	$\Omega$
		$V_{GS} = 4.5 V, I_D = 0.8 A$			1.2	
Forward Transconductance	$g_{fs}$	$V_{DS} = 15 V, I_D = 1.1 A$		5		S
Diode Forward Voltage	$V_{SD}$	$I_S = 0.8 A, V_{GS} = 0 V$		0.75		V
Dynamic						
Total Gate Charge	$Q_g$	$V_{DS} = 75 V, V_{GS} = 4.5 V, I_D = 1.1 A$		3.5		nC
Gate-Source Charge	$Q_{gs}$			1.3		
Gate-Drain Charge	$Q_{gd}$			1.5		
Turn-On Delay Time	$t_{d(on)}$	$V_{DD} = 75 V, R_L = 75 \Omega, I_D = 1.1 A,$ $V_{GEN} = 10 V, R_{GEN} = 6 \Omega$		4.4		nS
Rise Time	$t_r$			4.9		
Turn-Off Delay Time	$t_{d(off)}$			18.4		
Fall Time	$t_f$			4.9		
Input Capacitance	$C_{iss}$	$V_{DS} = 15 V, V_{GS} = 0 V, f = 1 MHz$		356		pF
Output Capacitance	$C_{oss}$			38		
Reverse Transfer Capacitance	$C_{rss}$			17		

Note:

- a. Pulse test: PW  $\leq$  300us duty cycle  $\leq$  2%.
- b. Guaranteed by design, not subject to production testing.



# ACE2391M N-Channel 150-V MOSFET

## Typical Performance Characteristics (N-Channel)

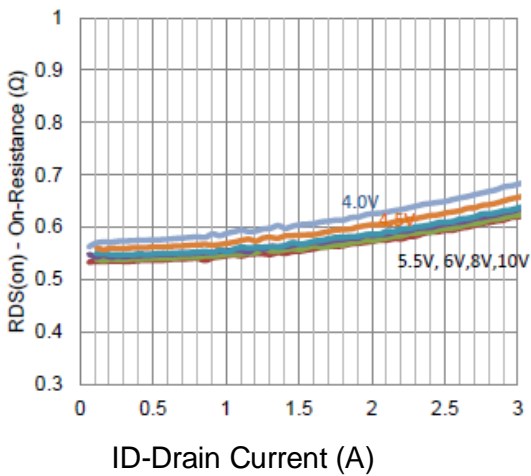

1. On-Resistance vs. Drain Current

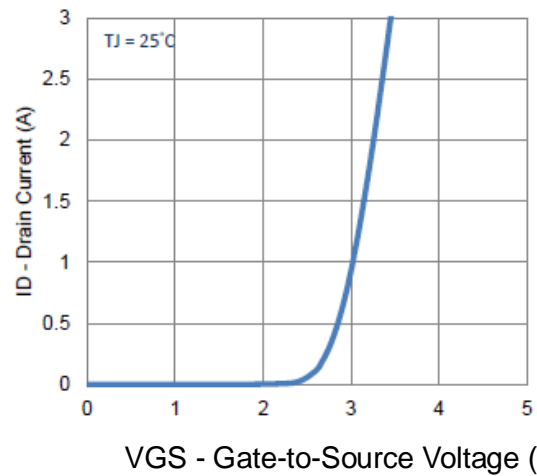

2. Transfer Characteristics

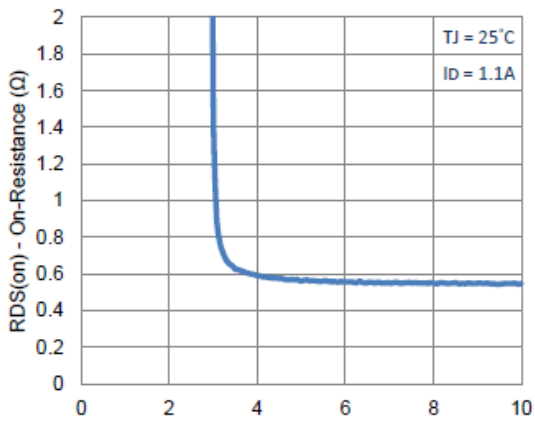

3. On-Resistance vs. Gate-to-Source Voltage

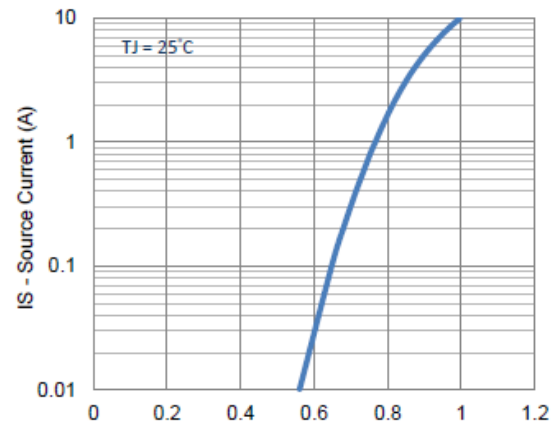

4. Drain-to-Source Forward Voltage

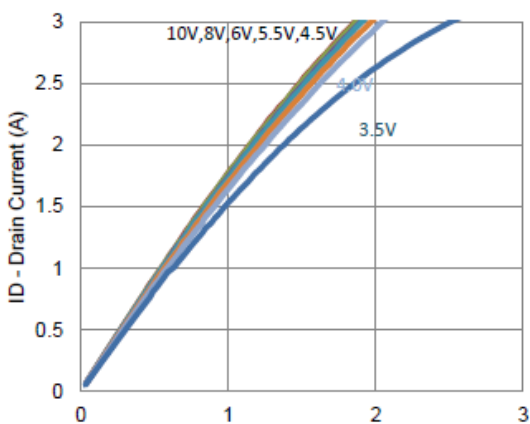

5. Output Characteristics

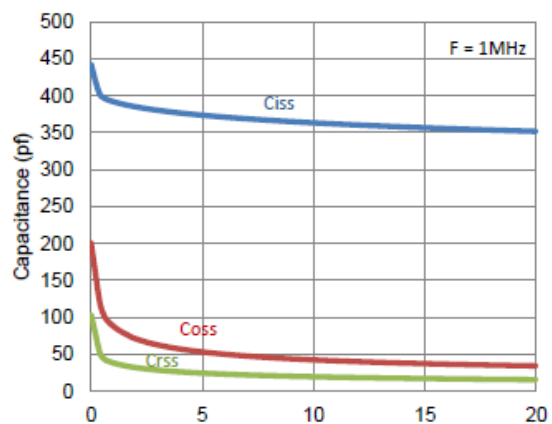

6. Capacitance



# ACE2391M

## N-Channel 150-V MOSFET

### Typical Performance Characteristics

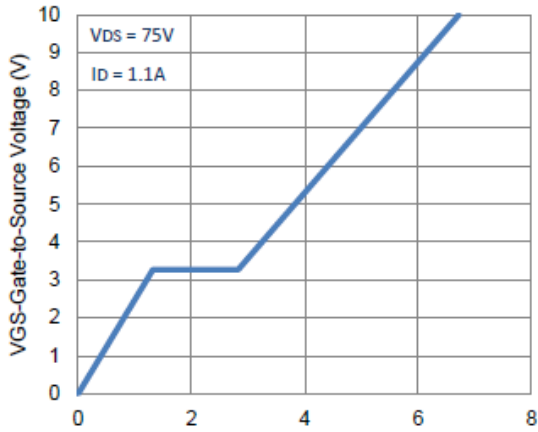

Qg - Total Gate Charge (nC)  
7. Gate Charge

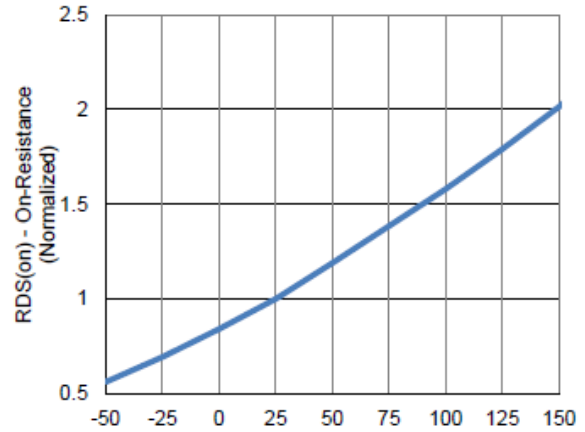

TJ - Junction Temperature(°C)  
8. Normalized On-Resistance Vs Junction Temperature

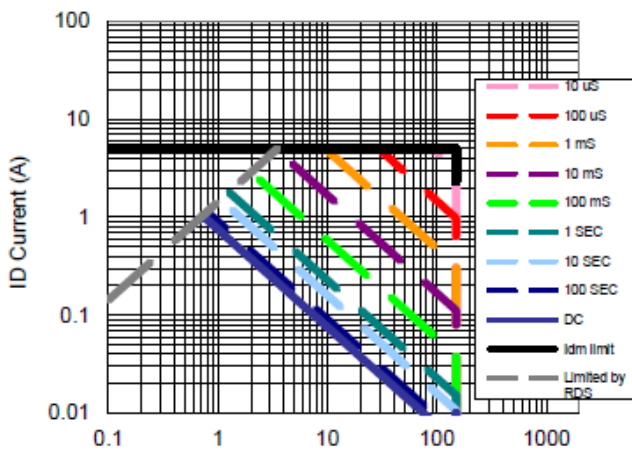

VDS Drain to Source Voltage (V)  
9. Safe Operating Area

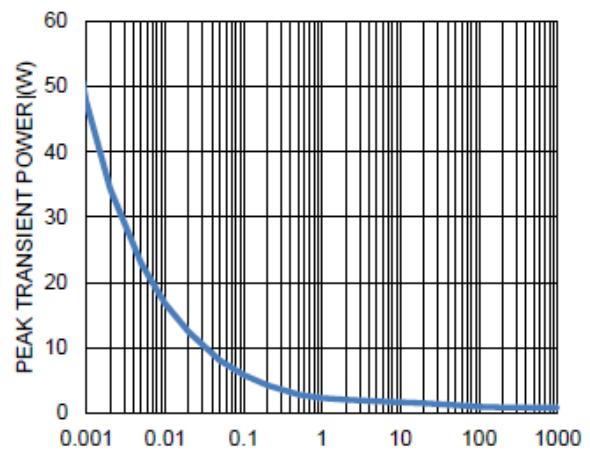

10. Single Pulse Maximum Power Dissipation

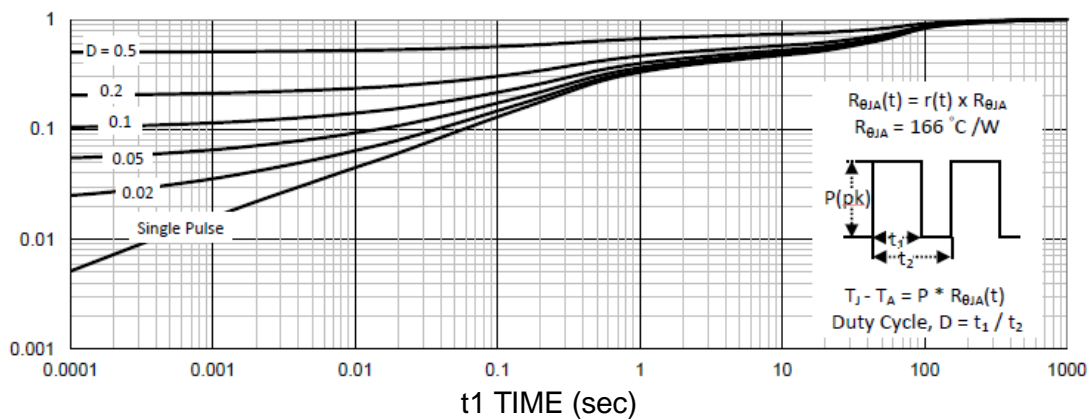

11. Normalized Thermal Transient Junction to Ambient



# ACE2391M

## N-Channel 150-V MOSFET

### Packing Information

STO-23-3

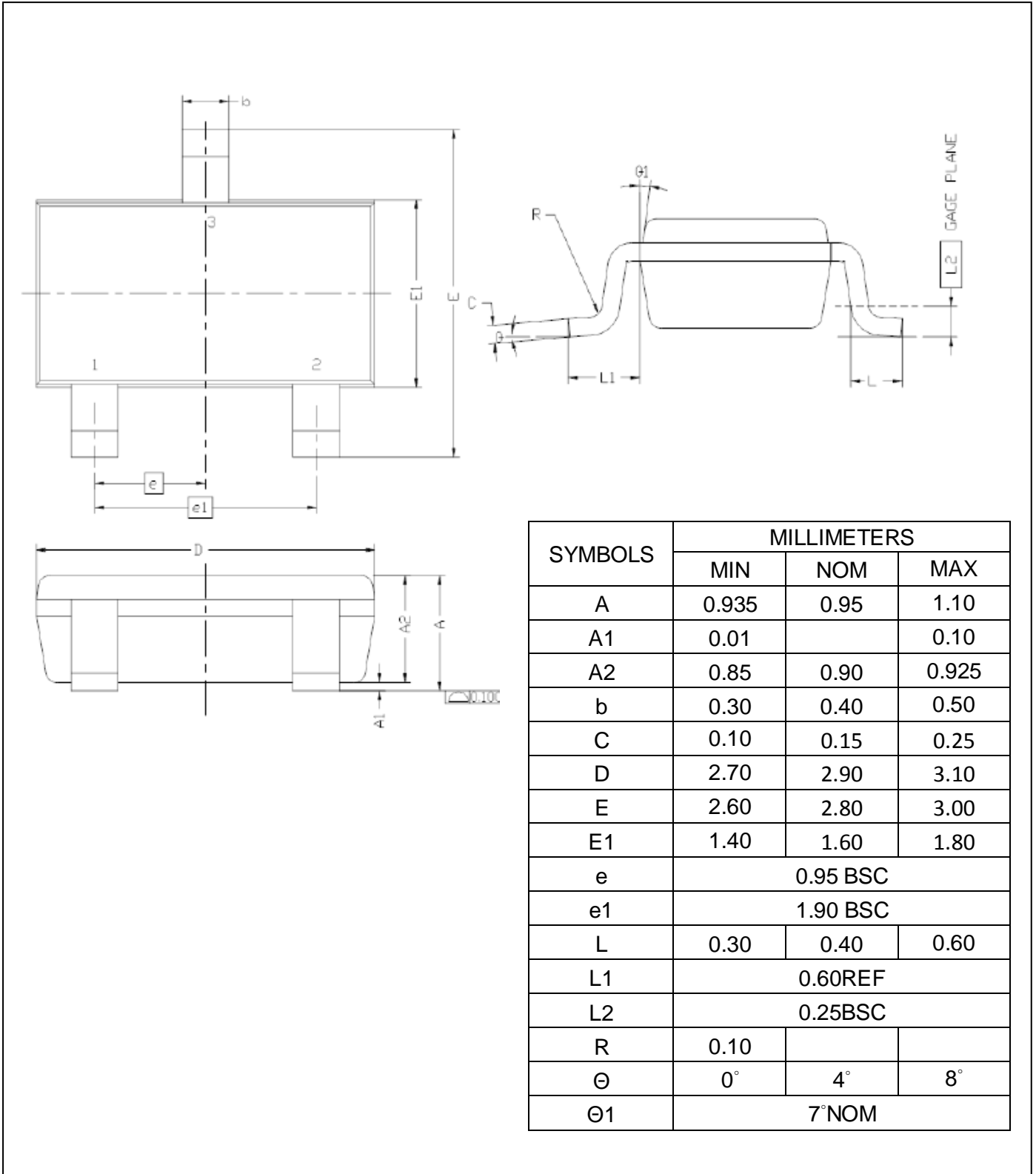

SYMBOLS	MILLIMETERS		
	MIN	NOM	MAX
A	0.935	0.95	1.10
A1	0.01		0.10
A2	0.85	0.90	0.925
b	0.30	0.40	0.50
C	0.10	0.15	0.25
D	2.70	2.90	3.10
E	2.60	2.80	3.00
E1	1.40	1.60	1.80
e	0.95 BSC		
e1	1.90 BSC		
L	0.30	0.40	0.60
L1	0.60REF		
L2	0.25BSC		
R	0.10		
$\Theta$	0°	4°	8°
$\Theta1$	7°NOM		



# ACE2391M

## N-Channel 150-V MOSFET

### Notes

ACE does not assume any responsibility for use as critical components in life support devices or systems without the express written approval of the president and general counsel of ACE Electronics Co., LTD. As used herein:

1. Life support devices or systems are devices or systems which, (a) are intended for surgical implant into the body, or (b) support or sustain life, and whose failure to perform when properly used in accordance with instructions for use provided in the labeling, can be reasonably expected to result in a significant injury to the user.
2. A critical component is any component of a life support device or system whose failure to perform can be reasonably expected to cause the failure of the life support device or system, or to affect its safety or effectiveness.

ACE Technology Co., LTD.  
<http://www.ace-ele.com/>