



# ACE4102E

## 2.5A, 3MHz Switching Charger with Dynamic Power Path Management

### Description

ACE4102E is a switching Li-Ion battery charger with dynamic power-path control and input current limiting. When a battery is connected, depending on the battery voltage, the DC-DC switching regulator either pre-conditions, fast-charges the battery or just regulates a system voltage ( $V_{SYS}$ ) to a preset voltage. It does not require an external sense resistor for current sensing. The charging current is determined by programming ISET1 or ISET2 pin, depending on the state of the USB\_DET. If USB\_DET is low, indicating an valid AC adapter input is present, the charge current is set by ISET1; otherwise, it is set by ISET2. When the battery voltage reaches the termination voltage i.e. 4.2V/4.35V, the charging path disconnects SYS to BATT. The ACE4102E also includes a dynamic power path when the SYS load current exceeds current limit of the DCDC regulator internally set, the SYS voltage falls below  $V_{BATT}$ , ACE4102E turns on the power-path to supplement the system load through the batter.

### Features

- Switching Charger with Power Path Management
- Up to 95% DC-DC Efficiency
- 50m $\Omega$  Power Path MOSFET
- Up to 2.5A Max charging current
- Instant on with a dead Battery or no Battery
- No battery detection
- No External Sense resistor
- Programmable USB and AC IN Charging Current

### Application

- Tablet, MID
- Smart Phone
- Power Bank

### Typical Application

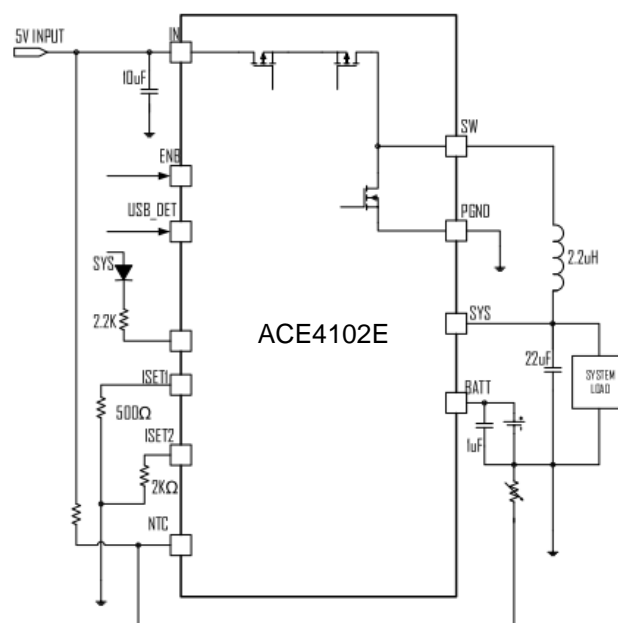

2A Switching Charger with Dynamic Power Path



# ACE4102E

## 2.5A, 3MHz Switching Charger with Dynamic Power Path Management

### Absolute Maximum Ratings

| Parameter                     | Max                      |
|-------------------------------|--------------------------|
| IN, BATT Voltage              | -0.3V ~ 6V               |
| All Other Pin Voltage         | VIN-0.3V ~ VIN0.3V       |
| SW,SYS,BATT to ground current | Internally limited       |
| Operating Temperature Range   | -40°C ~85°C              |
| Storage Temperature Range     | -55°C ~150°C             |
| Thermal Resistance            | $\theta_{JA}$<br>50 °C/W |

(Note: Exceeding these limits may damage the device. Exposure to absolute maximum rating conditions for long periods may affect device reliability.)

### Packaging Type

QFN3x3-16

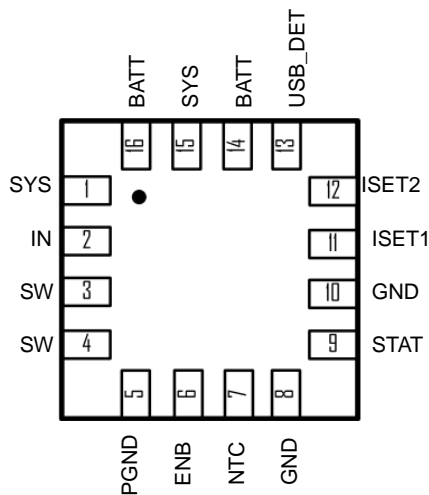

| QFN3x3-16 | Description | Function                                                                                                                                     |
|-----------|-------------|----------------------------------------------------------------------------------------------------------------------------------------------|
| 1.15      | SYS         | System Voltage Pin. It is also the Switching regulator's output pin. Connect and inductor and capacitor to form the output filter            |
| 2         | IN          | Input pin. Can be connected to an AC adaptor or a USB charger output. Bypass with a 10uF capacitor each to GND and PGND                      |
| 3.4       | SW          | Switching node of the Switching Regulator. Connect a 1uH to 2.2uH inductor from this pin to SYS                                              |
| 5         | PGND        | Power Ground. Bypass with a 10uF capacitor to IN with a shortest possible trace                                                              |
| 6         | ENB         | Active Low Enable pin. Tie this pin low to enable the Charging, tie high to disable Charging, while still keeping powerpath from BATT to SYS |
| 7         | NTC         | Thermistor input                                                                                                                             |
| 8.10      | GND         | Analog Ground Pin. Bypass with a 10uF capacitor to IN                                                                                        |



# ACE4102E

## 2.5A, 3MHz Switching Charger with Dynamic Power Path Management

|       |         |                                                                                                                                                                                                                                                               |
|-------|---------|---------------------------------------------------------------------------------------------------------------------------------------------------------------------------------------------------------------------------------------------------------------|
| 9     | STATS   | Status pin for Charging status indications. An open drain device capable of driving 10mA current                                                                                                                                                              |
| 11    | ISET1   | AC Fast Charge Current set pin for AC input. Connecting a Resistor between ISET1 to GND This sets the fast charge current value for AC adapter when USB_DET is low.                                                                                           |
| 12    | ISET2   | USB Charge Current set pin for USB input. Connecting a Resistor between ISET2 to GND This sets the charge current value for USB input when USB_DET is high.                                                                                                   |
| 13    | USB_DET | Charge current selecting input. Pull this pin low if an AC adapter is connected and select fast charging current to be set by ISET1. And set this pin high if a USB input is connected and select USB charging current to be set by ISET2. It is default low. |
| 14.16 | BATT    | Battery pin. Connect a Battery to this pin                                                                                                                                                                                                                    |

### Ordering information

ACE4102E XX XX + H

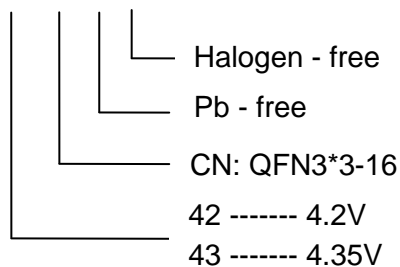

### Electrical Characteristics

( $V_{IN} = 5V$ , unless otherwise specified. Typical values are at  $T_A = 25^{\circ}C$ )

| Parameter                     | Conditions                    | Min | Typ  | Max | Units |
|-------------------------------|-------------------------------|-----|------|-----|-------|
| <b>IN INPUT</b>               |                               |     |      |     |       |
| INPUT Range                   |                               | 4.4 |      | 5.5 | V     |
| INPUT UVLO                    | Rising, Hys=500mV             |     | 4.35 |     | V     |
| INPUT Operating Current       | Switcher Enable, Switching    |     | 5    |     | uA    |
|                               | Switcher Enable, No Switching |     | 70   |     | uA    |
| BATT to INPUT leakage Current | Input Floating                |     | 0    | 5   | uA    |
| <b>DC-DC and SYS OUTPUT</b>   |                               |     |      |     |       |
| VSYSMIN                       | $I_{SYS}=1A$ , Default        |     | 3.6  |     | V     |
| VSYSMAX                       |                               |     | 4.5  |     | V     |
| Load Regulation               |                               |     | 40   |     | mV/A  |
| Line Regulation               | $V_{IN} = 4.75$ to $5.25V$    |     | 0.04 |     | %/V   |
| Switching Frequency           |                               |     | 3    |     | MHz   |
| Max duty                      |                               | 100 |      |     | %     |
| HIGHSIDE MOS RDSON            | $I_{SW} = 500mA$              |     | 100  |     | mΩ    |
| LOWSIDE MOS RDSON             | $I_{SW} = 500mA$              |     | 60   |     | mΩ    |
| HIGHSIDE Current limit        |                               |     | 3.5  |     | A     |



# ACE4102E

## 2.5A, 3MHz Switching Charger with Dynamic Power Path Management

|                               |                                                                                |       |      |       |            |
|-------------------------------|--------------------------------------------------------------------------------|-------|------|-------|------------|
| SYS UVLO                      | Falling, Hys=200mV                                                             |       | 2.25 |       | V          |
| Thermal Shutdown              | Rising, Hys=30oC                                                               |       | 160  |       | °C         |
| <b>POWER PATH Management</b>  |                                                                                |       |      |       |            |
| BATT TO SYS RDSON             |                                                                                |       | 50   |       | mΩ         |
| <b>BATTERY CHARGER</b>        |                                                                                |       |      |       |            |
| Battery CV voltage            | $I_{BAT} = 0mA$ , default                                                      | 4.16  | 4.2  | 4.24  | V          |
|                               |                                                                                | 4.307 | 4.35 | 4.393 |            |
| Charger Restart Threshold     | From DONE to FastCharge                                                        |       | -200 |       | mV         |
| Battery Pre-condition Voltage | $V_{BAT}$ Rising Hys=180mV                                                     |       | 2.9  |       | V          |
| Pre-Condition Charge Current  |                                                                                |       | 100  |       | mA         |
| AC Fast Charge Current        | $R_{ISET1} = 500\Omega$ , USB_DET= low<br>$I_{charge} = 1V * 1000 / R_{ISET1}$ |       | 2    |       | A          |
| USB Charge Current            | $R_{ISET2} = 2K\Omega$ , USB_DET= high<br>$I_{charge} = 1V * 1000 / R_{ISET2}$ |       | 0.5  |       | A          |
| Pre-condition Timer           |                                                                                |       | 120  |       | min        |
| Fast-Charge Timer             |                                                                                |       | 120  |       | min        |
| <b>THERMISTOR MONITOR</b>     |                                                                                |       |      |       |            |
| NTC Threshold, Cold           | Charger Suspended                                                              |       | 76.5 |       | % $V_{IN}$ |
| NTC Threshold, Hot            | Charger Suspended                                                              |       | 35   |       | % $V_{IN}$ |
| NTC Threshold Hysteresis      |                                                                                |       | 1.5  |       | % $V_{IN}$ |
| NTC Disable Threshold         |                                                                                |       | 100  |       | mV         |
| NTC Input Leakage             |                                                                                |       | 0    |       | uA         |
| <b>LOGIC INPUT, STATS</b>     |                                                                                |       |      |       |            |
| ENB Logic Input High          |                                                                                | 1.6   |      |       | V          |
| ENB Logic Input Low           |                                                                                |       |      | 0.3   | V          |
| STAT Output Low Voltage       | $I_{STATS} = 10mA$                                                             |       |      | 0.2   | V          |

### Typical Characteristics

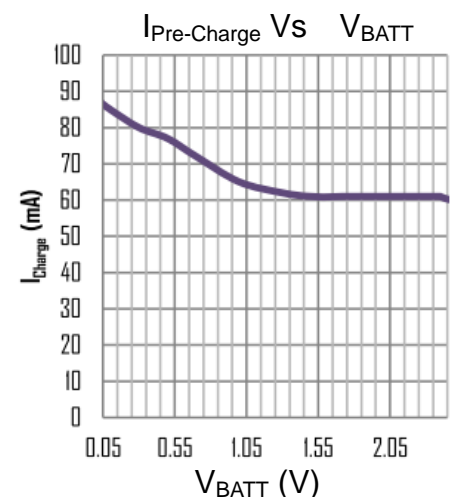
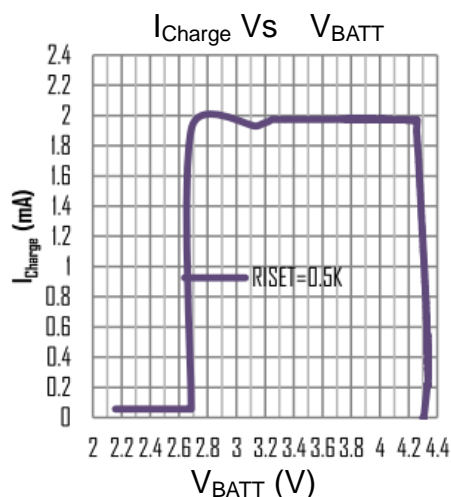
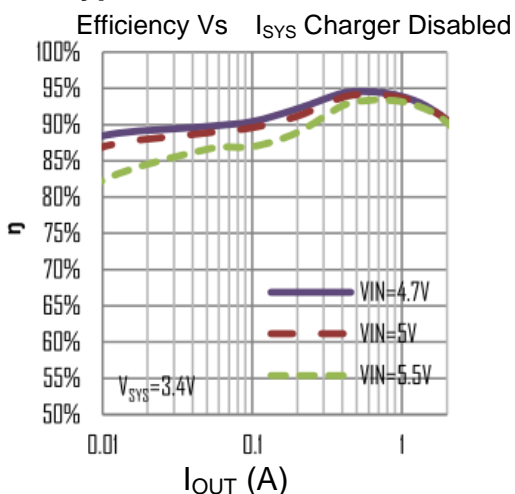



# ACE4102E

## 2.5A, 3MHz Switching Charger with Dynamic Power Path Management

$V_{SYS}$   $V_s$   $I_{SYS}$

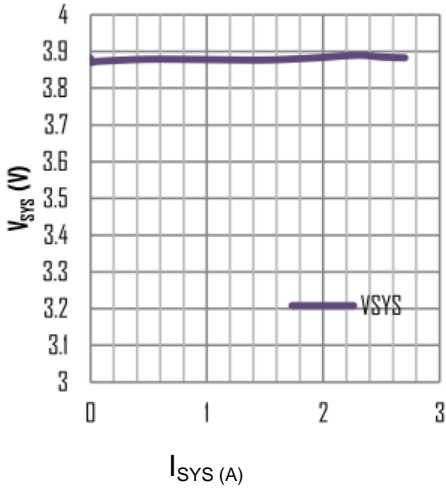

$V_{SYS}$   $V_s$  Temperature

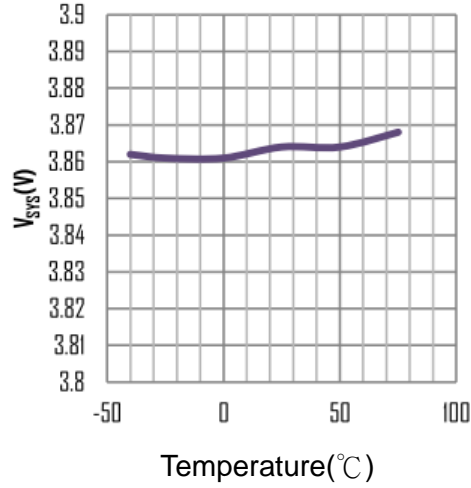

$I_{Charge}$   $V_s$  Temperature  
Thermal Foldback

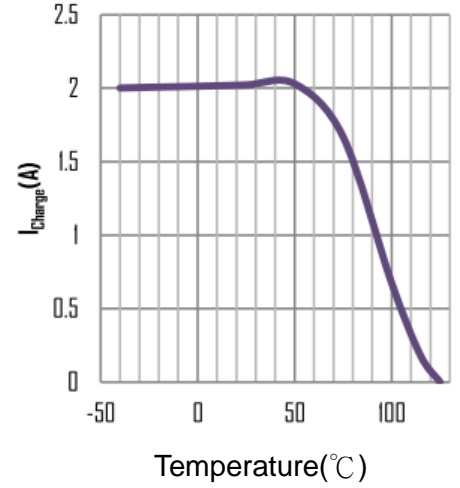

Battery Inserted During Detection

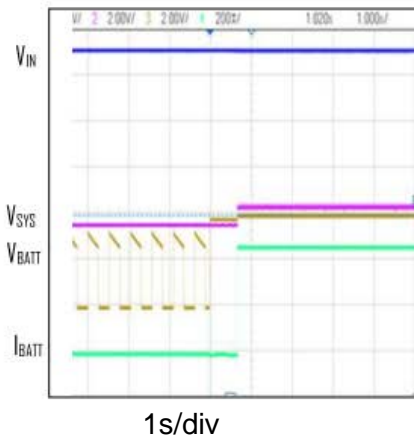

Battery Pulled During Charging

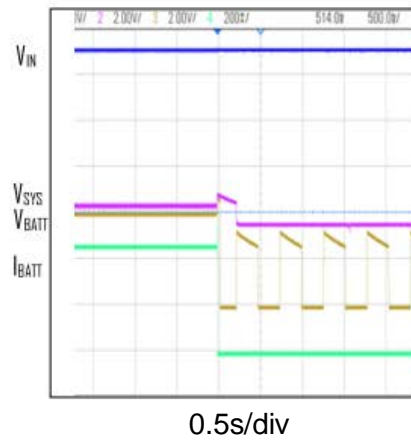

IN Plug-In with Battery Connected

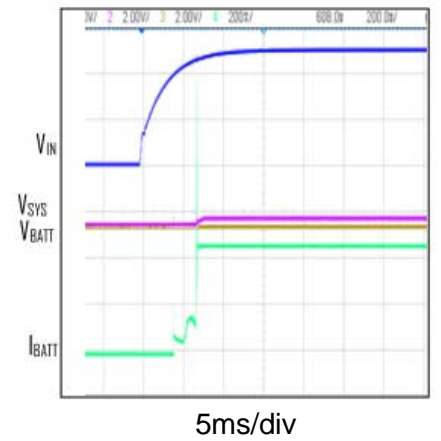

$V_{SYS}$  Load Step Into Reduce Charging

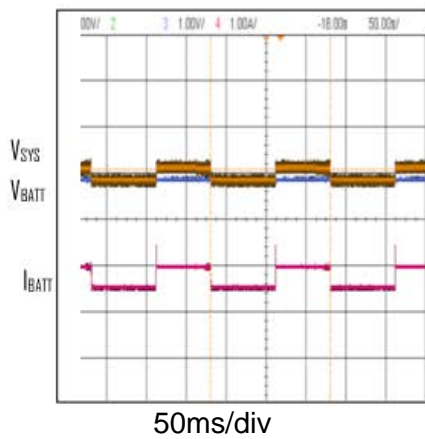

$V_{SYS}$  Load Step Into Supplement Mode

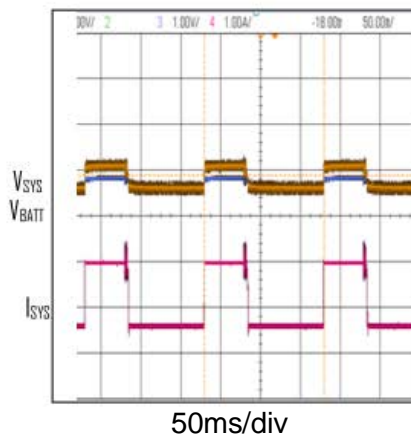

$V_{SYS}$  Load Step Into IN DPPM Mode, IIN LIMIT=0.5A

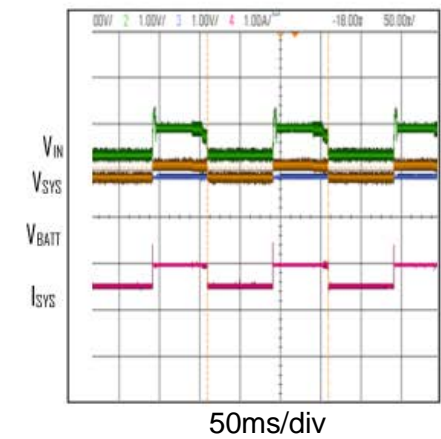



# ACE4102E

## 2.5A, 3MHz Switching Charger with Dynamic Power Path Management

DCDC PFM SWITCHING WAVEFORM  
I<sub>sys</sub>=10mA

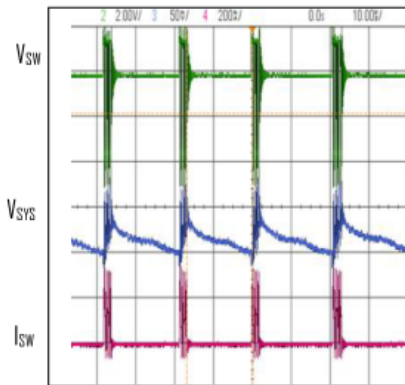

10ms/div

DCDC PWM SWITCHING WAVEFORM  
I<sub>sys</sub>=2A

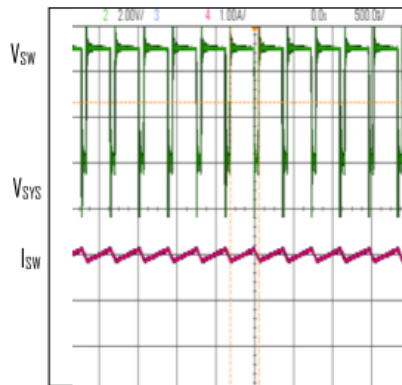

0.5us/div

IN UNPLUGGED

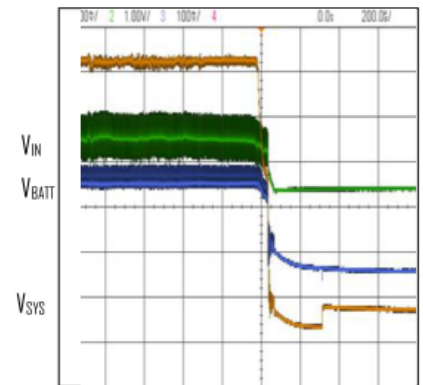

200us/div

### TYPICAL APPLICATION

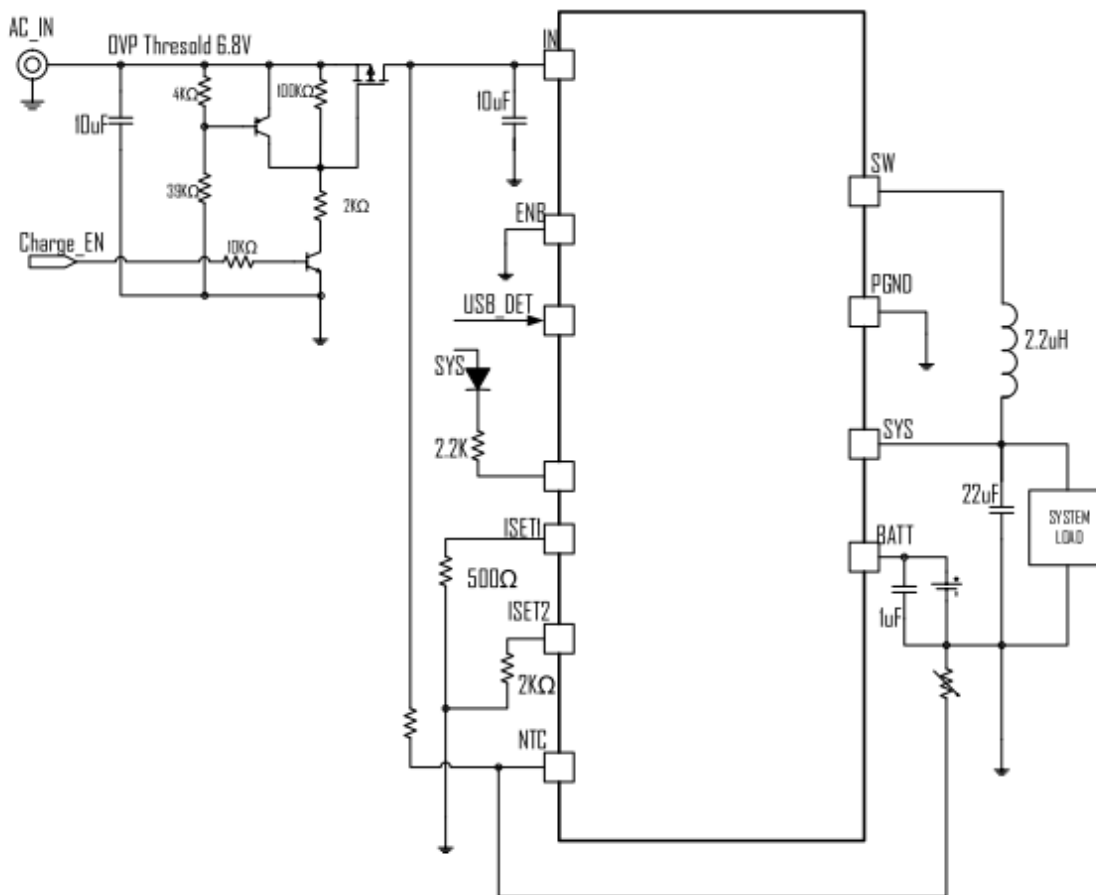

2A Switching Charger with Dynamic Power Path with OVP protection and Charge Enable



# ACE4102E

## 2.5A, 3MHz Switching Charger with Dynamic Power Path Management

### PCB GUIDELINE

PCB layout cautions of ACE4102E is shown below. The input capacitor (Cin) between Vin (Pin2) and PGND (Pin5) is always to be placed closest to the IC. SW wire can be laid through the gap between the 2 Cin terminals. It can go underneath the Cin. For all pins that needs to be shorted to GND, please connect them to GND (Pin10), not to PGND (Pin5). A real PCB layout example is also listed below for reference.

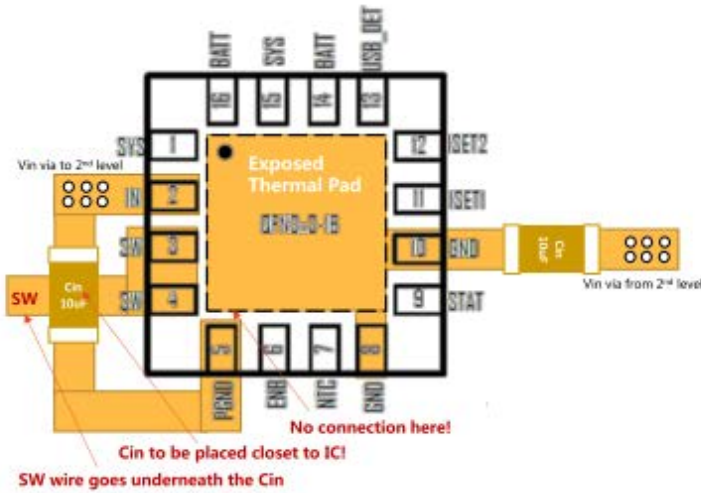

PCB cautions of ACE4102E

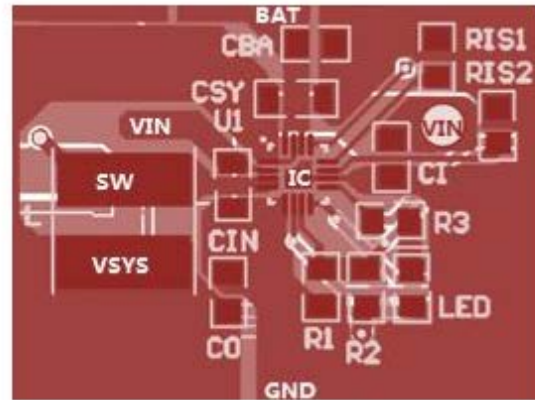

Real DEMO board PCB for reference



### Packing Information

#### QFN3\*3-16

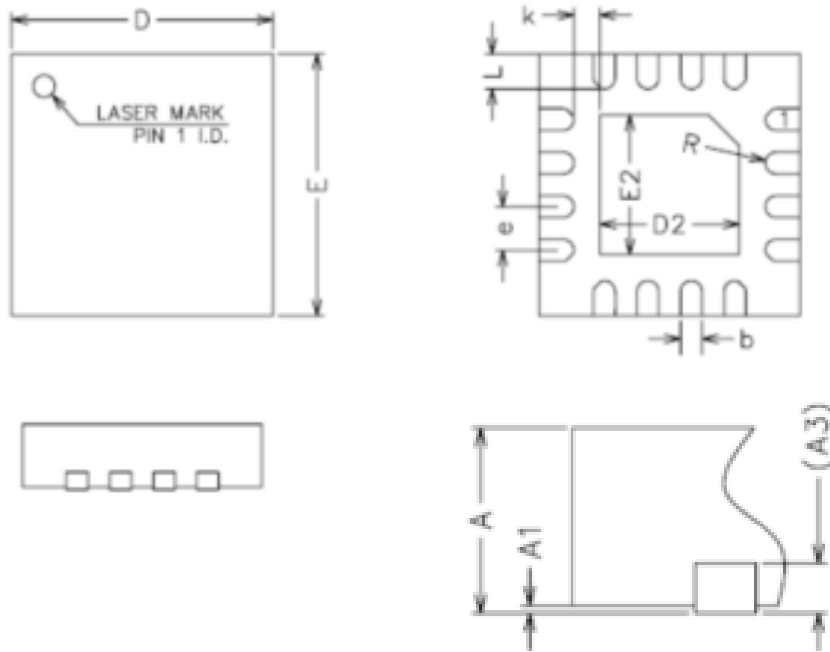

NOTE: ALL DIMENSIONS REFER TO JEDEC STANDRAD MO-220 WEED-4.

| Symbol | Dimensions in millimeters |      |      |
|--------|---------------------------|------|------|
|        | Min.                      | Nom. | Max. |
| A      | 0.70                      | 0.75 | 0.80 |
| A1     | -                         | 0.02 | 0.05 |
| A3     | 0.20REF                   |      |      |
| b      | 0.20                      | 0.25 | 0.30 |
| D      | 2.90                      | 3.00 | 3.10 |
| E      | 2.90                      | 3.00 | 3.10 |
| D2     | 1.55                      | 1.65 | 1.75 |
| E2     | 1.55                      | 1.65 | 1.75 |
| e      | 0.40                      | 0.50 | 0.60 |
| k      | 0.20                      | -    | -    |
| L      | 0.35                      | 0.40 | 0.45 |
| R      | 0.09                      | -    | -    |





# ACE4102E

## 2.5A, 3MHz Switching Charger with Dynamic Power Path Management

### Notes

ACE does not assume any responsibility for use as critical components in life support devices or systems without the express written approval of the president and general counsel of ACE Electronics Co., LTD. As sued herein:

1. Life support devices or systems are devices or systems which, (a) are intended for surgical implant into the body, or (b) support or sustain life, and whose failure to perform when properly used in accordance with instructions for use provided in the labeling, can be reasonably expected to result in a significant injury to the user.
2. A critical component is any component of a life support device or system whose failure to perform can be reasonably expected to cause the failure of the life support device or system, or to affect its safety or effectiveness.

ACE Technology Co., LTD.  
<http://www.ace-ele.com/>