



# ACE4435B

## P-Channel Enhancement Mode Field Effect Transistor

### Description

The ACE4435B uses advanced trench technology to provide excellent  $R_{DS(ON)}$ , and ultra-low low gate charge. This device is suitable for use as a load switch or in PWM applications.

### Features

- $V_{DS}(V)=-30V$
- $I_D=-6.5A$  ( $V_{GS}=-10V$ )
- $R_{DS(ON)} < 40m\Omega$  ( $V_{GS}=-10V$ )
- $R_{DS(ON)} < 50m\Omega$  ( $V_{GS}=-4.5V$ )
- 

### Absolute Maximum Ratings

Parameter	Symbol	Max	Unit
Drain-Source Voltage	$V_{DS}$	-30	V
Gate-Source Voltage	$V_{GS}$	$\pm 20$	V
Drain Current (Continuous) * AC	$I_D$	$T_A=25^\circ C$	-6.5
		$T_A=70^\circ C$	-5.3
Drain Current (Pulse) * B	$I_{DM}$	-30	A
Power Dissipation	$P_D$	$T_A=25^\circ C$	3
		$T_A=70^\circ C$	2.1
Operating and Storage Temperature Range	$T_J, T_{STG}$	-55 to 150	$^\circ C$

### Packaging Type

SOP-8

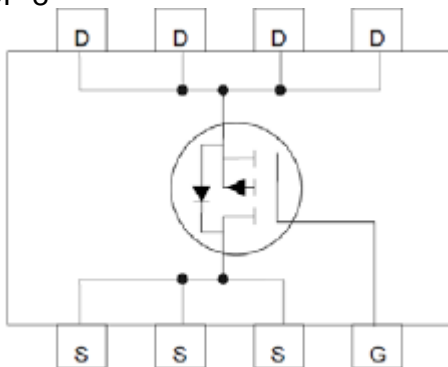

### Ordering information

ACE4435B FM + H

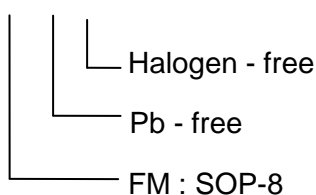



# ACE4435B

## P-Channel Enhancement Mode Field Effect Transistor

### Electrical Characteristics

$T_A=25^{\circ}\text{C}$  unless otherwise noted

Parameter	Symbol	Conditions	Min.	Typ.	Max.	Unit
Static						
Drain-Source Breakdown Voltage	$V_{(BR)DSS}$	$V_{GS}=0V, I_D=-250\mu A$	-30			V
Zero Gate Voltage Drain Current	$I_{DSS}$	$V_{DS}=-30V, V_{GS}=0V$			-1	$\mu A$
Gate Threshold Voltage	$V_{GS(th)}$	$V_{DS}=V_{GS}, I_{DS}=-250\mu A$	-1.2	-1.4	-2.7	V
Gate Leakage Current	$I_{GSS}$	$V_{GS}=\pm 20V, V_{DS}=0V$			100	nA
Static Drain-Source On-Resistance	$R_{DS(ON)}$	$V_{GS}=-10V, I_D=-5.7A$		30	40	m $\Omega$
		$V_{GS}=-4.5V, I_D=-4.4A$		38	50	
Forward Transconductance	$g_{FS}$	$V_{GS}=-5V, I_D=-5.7A$		11		S
Diode Forward Voltage	$V_{SD}$	$I_{SD}=-2.3A, V_{GS}=0V$		-0.82	-1.2	V
Maximum Body-Diode Continuous Current	$I_S$				-2.3	A
Switching						
Total Gate Charge	$Q_g$	$V_{GS}=-10V, V_{DS}=-15V, I_D=-6A$		18.3	23.79	nC
Gate-Source Charge	$Q_{gs}$			2.4	3.12	
Gate-Drain Charge	$Q_{gd}$			3.1	4.03	
Turn-On Delay Time	$T_{d(on)}$	$V_{GS}=-10V, V_{DS}=-15V, R_L=15\Omega, R_{GEN}=6\Omega$		12.4	24.8	ns
Turn-Off Delay Time	$t_{d(off)}$			41.1	82.2	
Dynamic						
Input Capacitance	$C_{iss}$	$V_{GS}=0V, V_{DS}=-15V, f=1MHz$		971.5		pF
Output Capacitance	$C_{oss}$			235.1		
Reverse Transfer Capacitance	$C_{rss}$			82.7		

Note: 1. The value of  $R_{\theta JA}$  is measured with the device mounted on 1in<sup>2</sup> FR-4 board with 2oz. Copper, in a still air environment with  $T_A=25^{\circ}\text{C}$ . The value in any given application depends on the user's specific board design.

2. Repetitive rating, pulse width limited by junction temperature.

3. The current rating is based on the  $t \leq 10s$  junction to ambient thermal resistance rating.



**Typical Performance Characteristics**

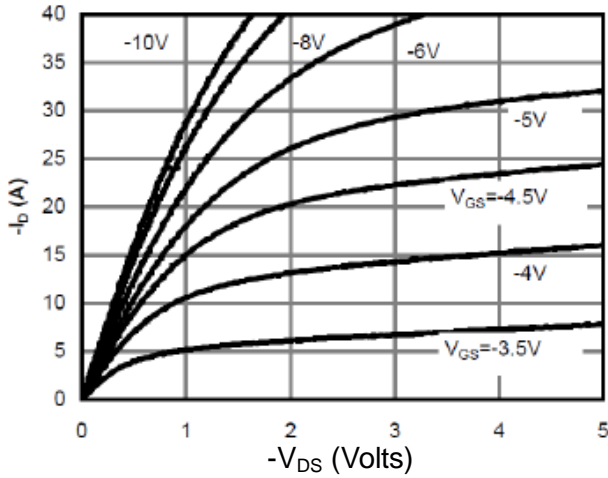

On-Region Characteristics

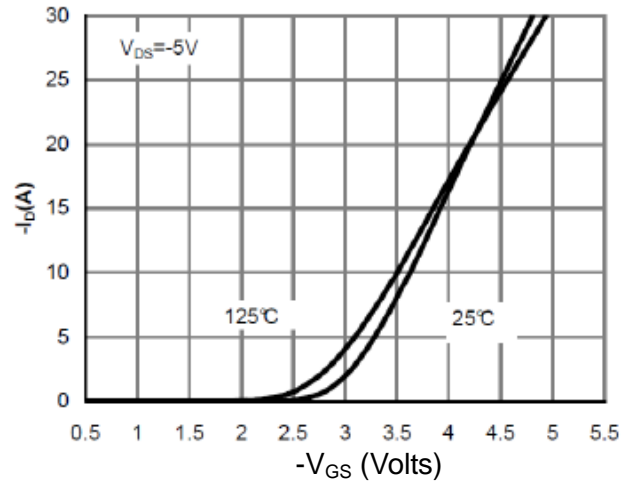

Transfer Characteristics

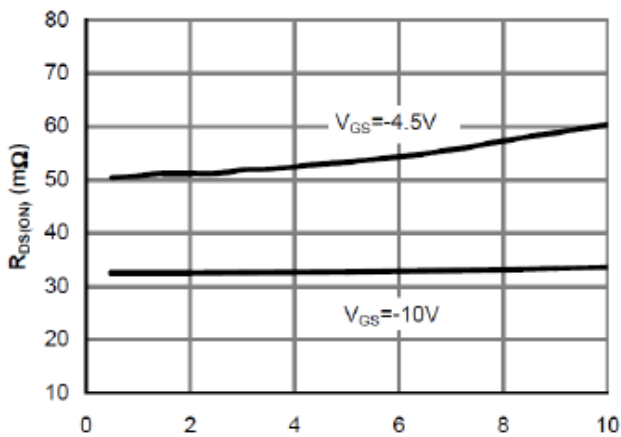

On-Resistance vs. Drain Current and Gate Voltage

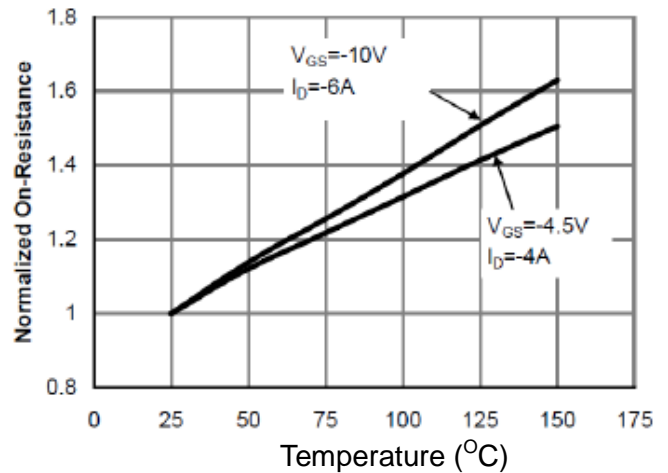

On-Resistance vs. Junction Temperature

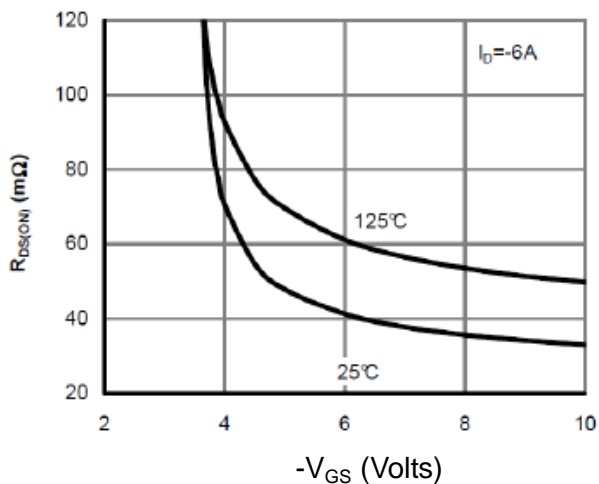

On-Resistance vs. Gate-Source Voltage

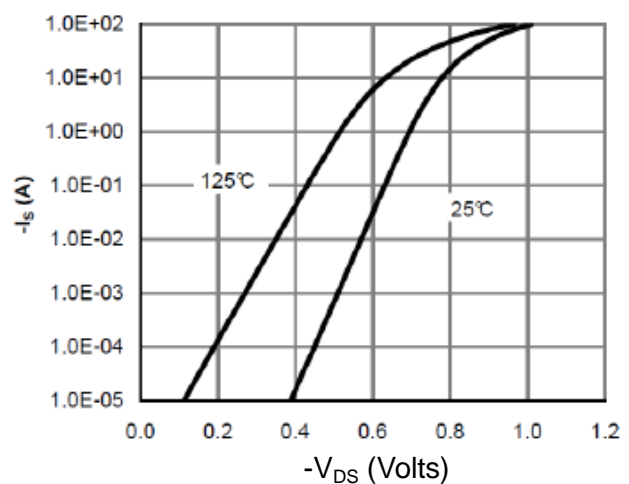

Body-Diode Characteristics



# ACE4435B

## P-Channel Enhancement Mode Field Effect Transistor

### Typical Performance Characteristics

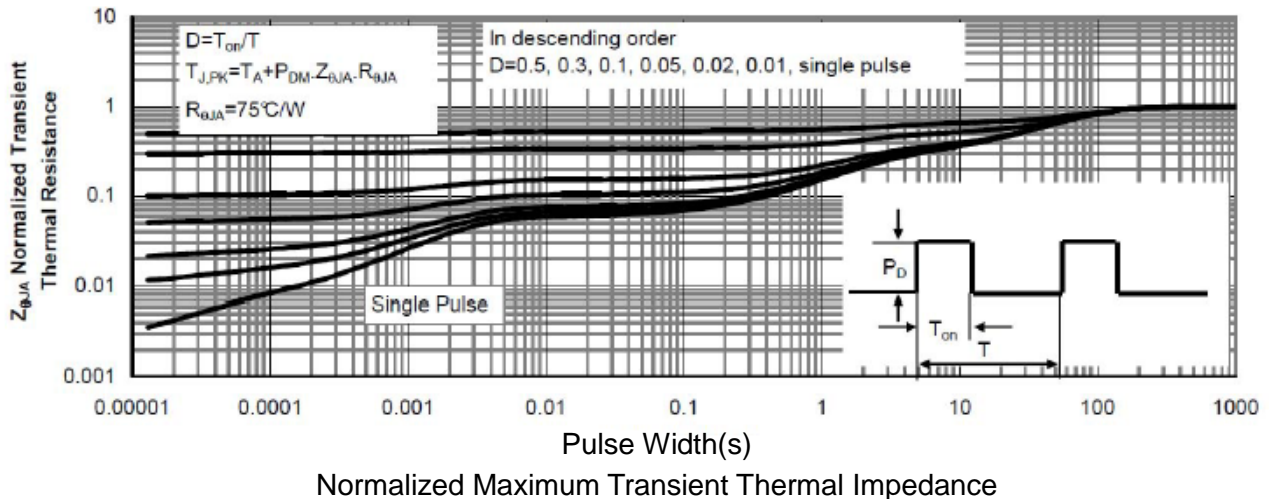
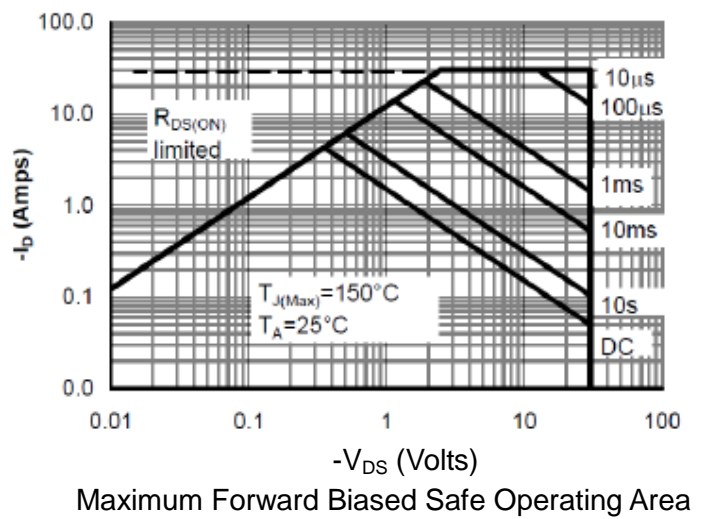
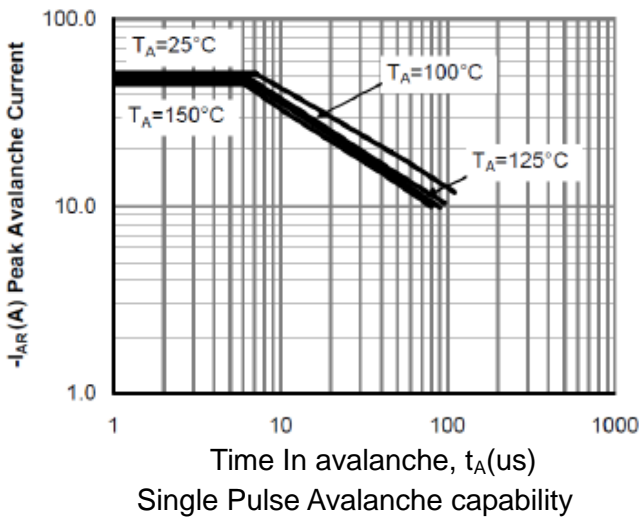
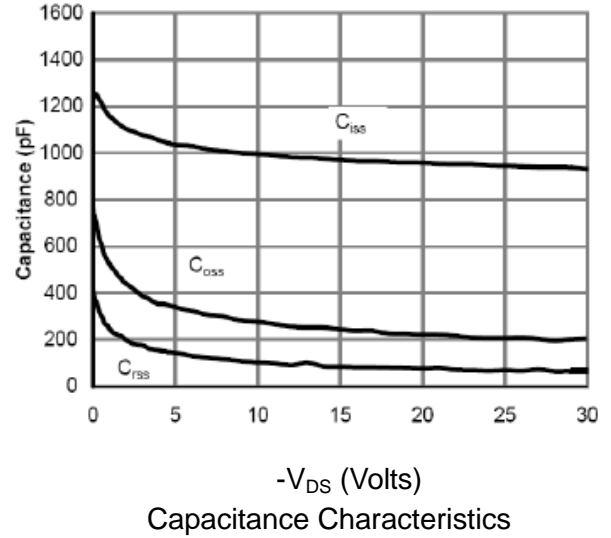
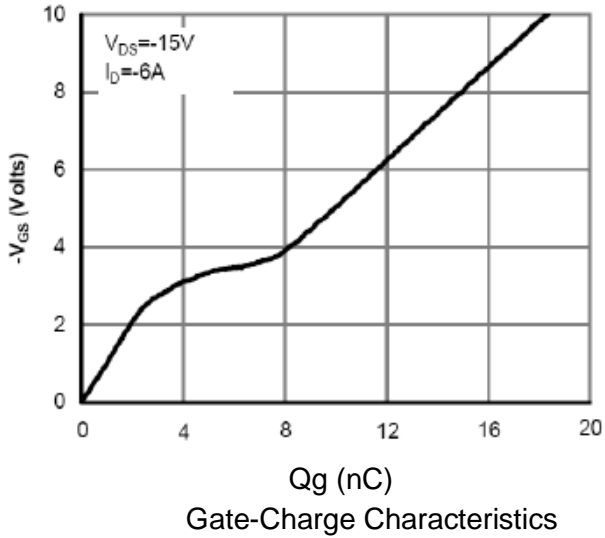



**Packing Information**

**SOP-8**

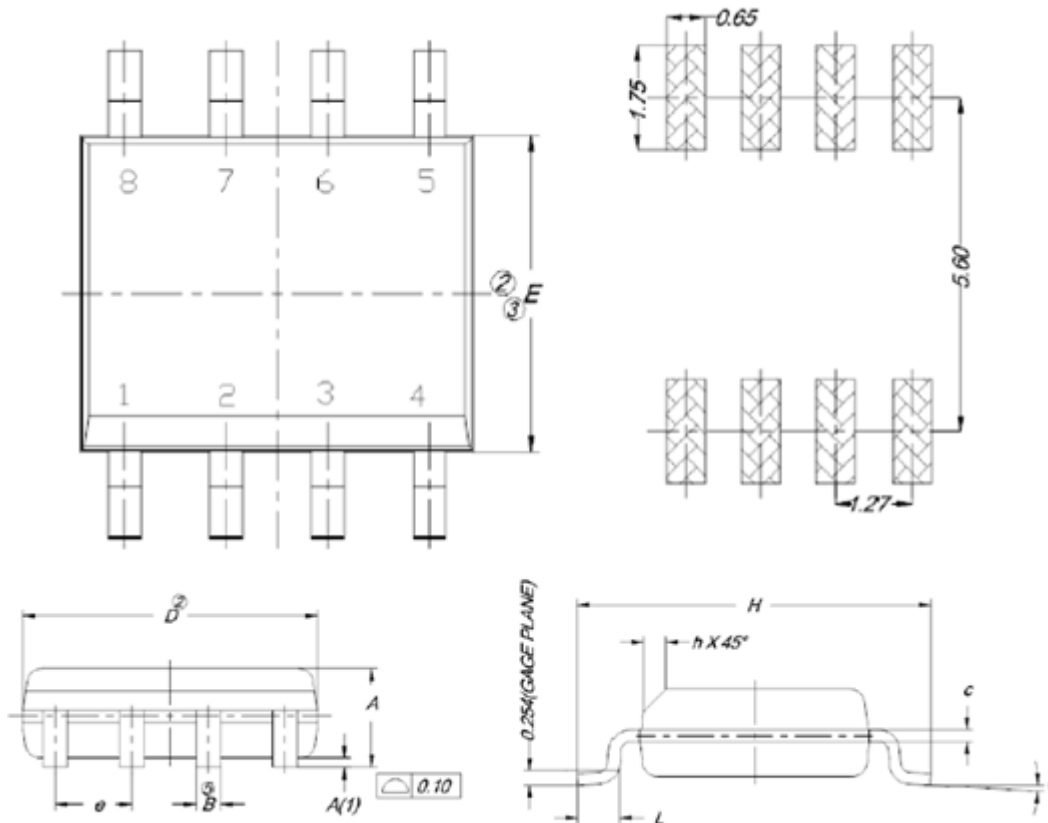

DIM	MILLMETERS		
	MIN	NOM	MAX
A	1.35	1.55	1.75
A(1)	0.10	0.18	0.25
B	0.38	0.45	0.51
C	0.19	0.22	0.25
D	4.80	4.90	5.00
E	3.80	3.90	4.00
e	1.27 BSC		
H	5.8	6.00	6.20
L	0.50	0.72	0.93
a	0°	4°	8°
h	0.25	0.38	0.50

Unit: mm



# ACE4435B

## P-Channel Enhancement Mode Field Effect Transistor

### Notes

ACE does not assume any responsibility for use as critical components in life support devices or systems without the express written approval of the president and general counsel of ACE Electronics Co., LTD. As sued herein:

1. Life support devices or systems are devices or systems which, (a) are intended for surgical implant into the body, or (b) support or sustain life, and whose failure to perform when properly used in accordance with instructions for use provided in the labeling, can be reasonably expected to result in a significant injury to the user.
2. A critical component is any component of a life support device or system whose failure to perform can be reasonably expected to cause the failure of the life support device or system, or to affect its safety or effectiveness.

ACE Technology Co., LTD.  
<http://www.ace-ele.com/>